

USER MANUAL



Thank you for choosing Better Bathrooms.
Please read this manual before installing your product
and keep for future reference.

better 
bathrooms

Product Code – BeBa_27203

Nerja 60cm Mirror – Concrete



- **Multi-person assembly**
- **We always recommend using professional tradespeople to install your product**

V1_14.12.2020

Congratulations on your purchase

And welcome to our growing gang of savvy shoppers

We're on a mission to bring you extraordinary bathroom products, for less. From modern to traditional style ceramics, plus the gorgeous fixtures, fittings and furniture to match. So, you can fall in love with your space every single day.

As one of the UK's largest independent bathroom stores, we've received countless awards; including the National Business Awards UK, the Digital Entrepreneur Awards and being placed on The Sunday Times Fast Track 100.

We hope your new product exceeds your highest expectations. However, if you experience any problems, please:

- call our friendly UK call centre on **03303903062** (9am-7pm Monday to Friday, or 10am-4pm Saturday and Sunday), or
- send us a message via **customerservices@buyitdirect.co.uk**

Important information

- Please read these instructions thoroughly and retain for future reference
- Please ensure the product is installed level on all 4 plains
- Use cut out screw holes if provided to fix the mirror unit to the wall
- Please inspect the product fully for any damage or defects prior to installation
- **Always check all wall before drilling to prevent damage to pipes and cables.**

Mirror Weight (Kg)	L Hook Bearing Capacity(Kg)
14,00	100,00

PARTS / DIAGRAMS

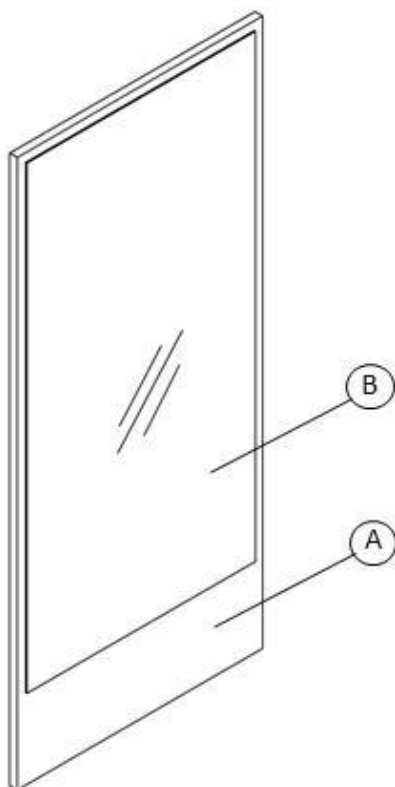



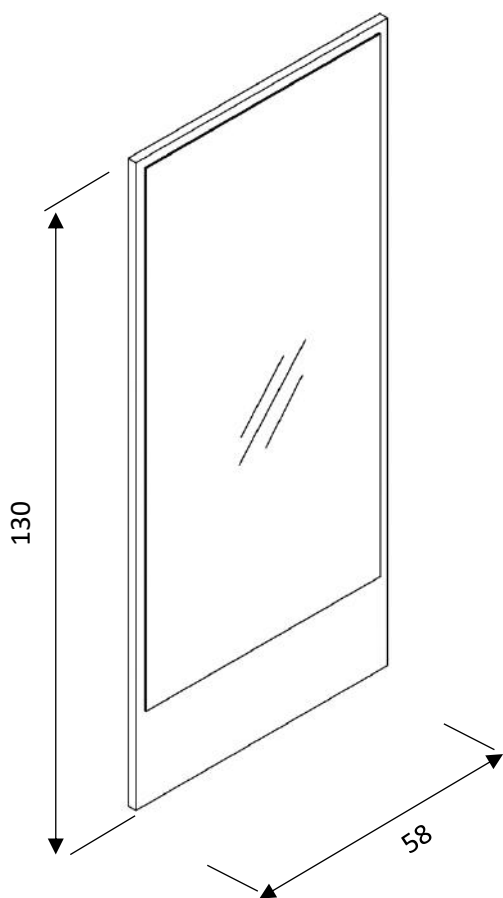

A – MIRROR REAR PANEL

B – MIRROR

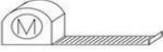

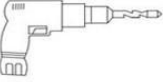
NECESSARY EQUIPMENT



			
			

Installation

Please spend 5 minutes reading this section before commencing with the installation of your new furniture

1. Should any of your items have a defect, please do not install as returns will not be accept once fitted.
2. We advise that you use a qualified person to install your units, as any issues relating to poor fitting will not be accepted by the supplier.
3. This product is water resistant but NOT waterproof and therefore the room must be well ventilated and any standing water must be wiped dry after use.
4. Fixings and wall type must be sufficient to support the unit, the fixings supplied are for solid wall fixing.

UPPER MODULE FITTINGS CHECKLIST

		QTY
01	 L Hook	2
02	 Dowel	2
03	 Sealing Profile	1

1

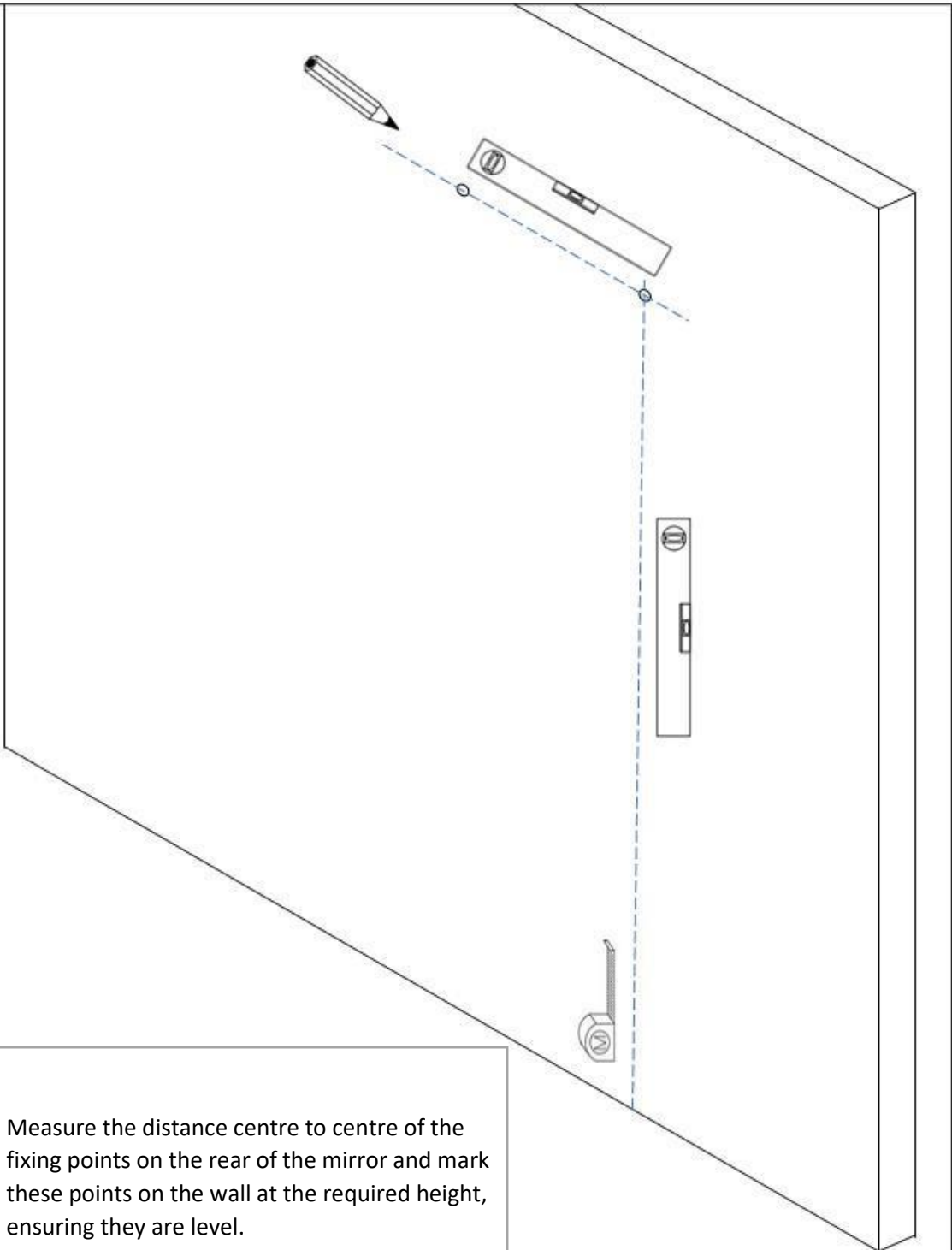

Info :

- 1- Measure the distance centre to centre of the fixing points on the rear of the mirror and mark these points on the wall at the required height, ensuring they are level.
- 2- 2- To do this use a tape measure and spirit level.

2

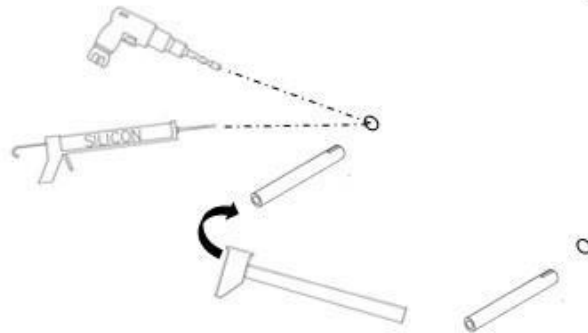

Info :

1- Drill the holes into the wall at 7 mm diameter and to a depth of 100 mm.

2- Apply a small amount of silicone into the hole.

3- Insert the dowels (Wall plugs) into the holes and tap flush to the wall surface using a hammer.

3

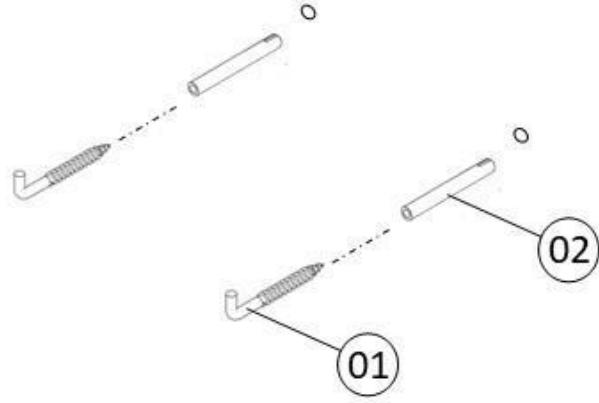

01



2

L Hook

02



2

Dowel

4

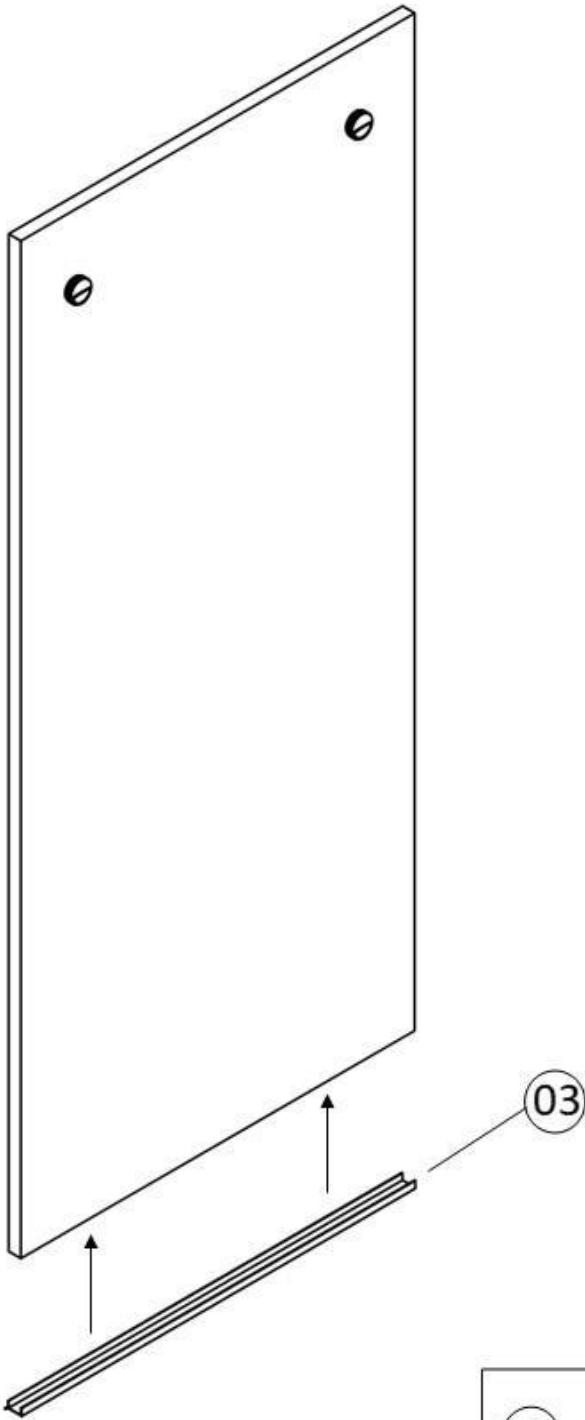

03		1 Sealing Profile
----	---	--------------------------

5

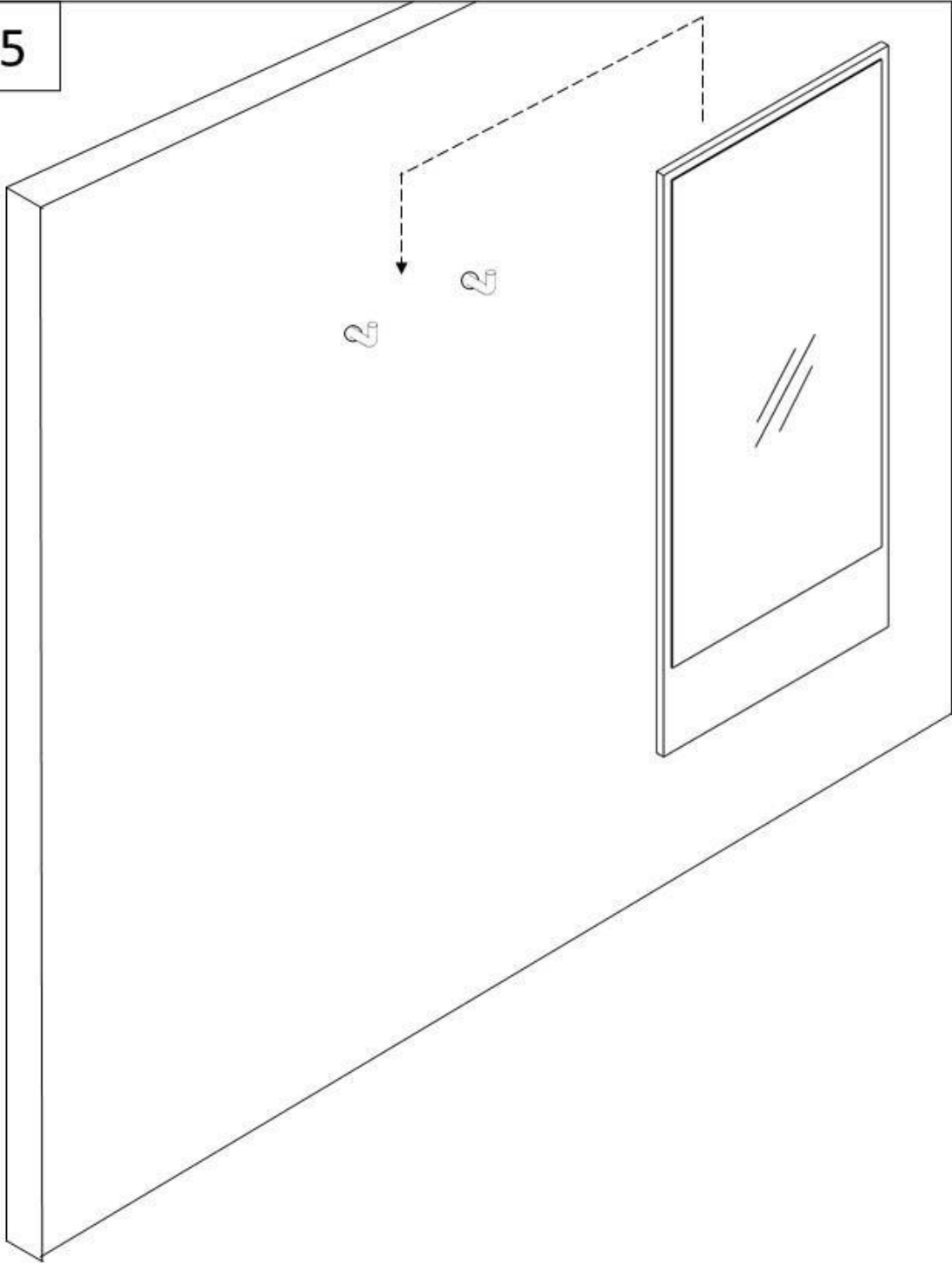

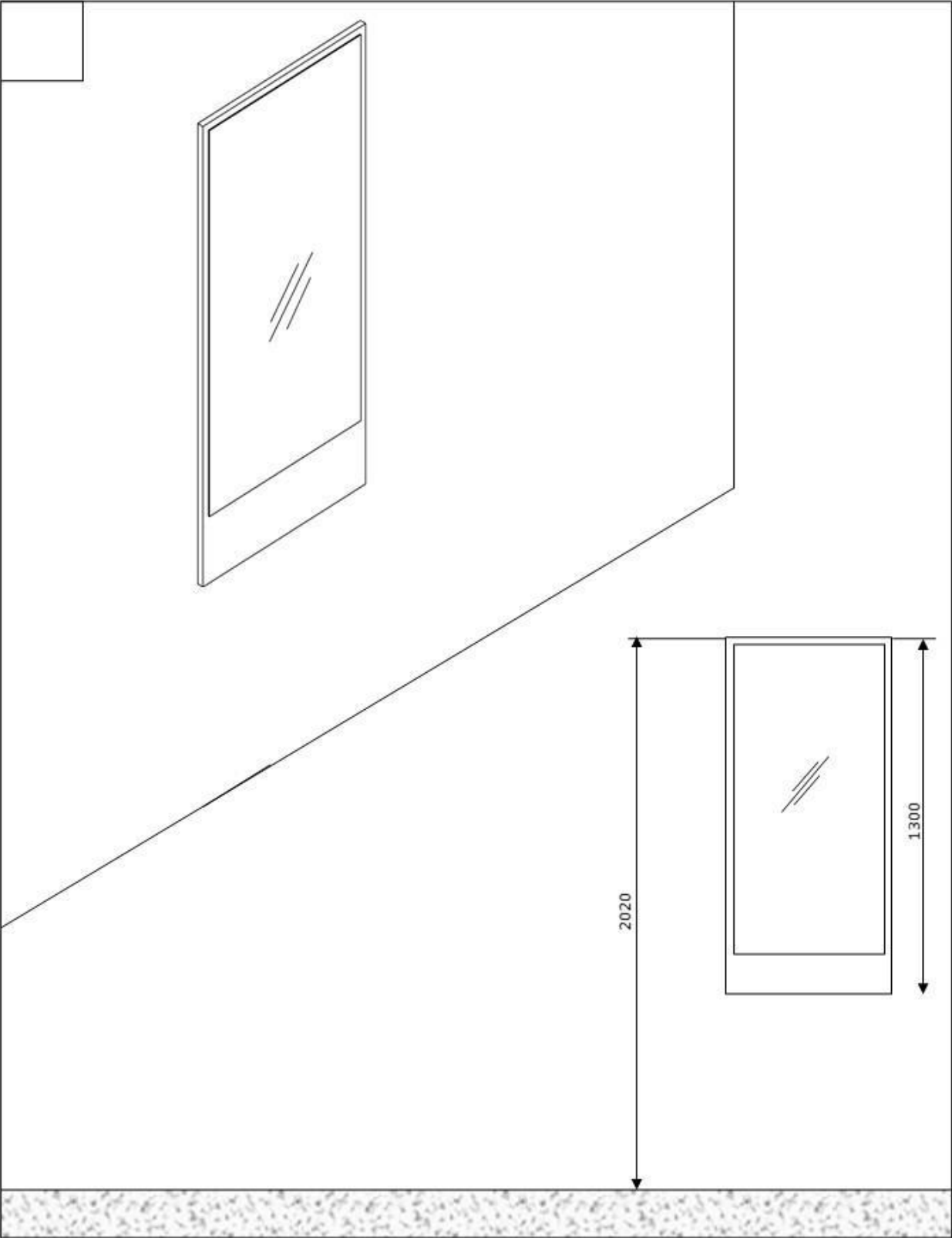

Maintenance

Please note that although these units have been designed to give years of pleasure and satisfaction, you will help maintain the original beauty of your bathroom by following these guidelines.

Carcass components

Do not use polish on any surfaces. A damp cloth with soapy water will clean off most marks or spills. On no account should any spillage, even water, be allowed to lie on the surface. Bleaches scouring pads and multi-surface cleaners should not be used.

Temperature, humidity, ventilation and proximity

Avoid excessive change in temperature and humidity. We would advise an extractor fan to be installed in all bathrooms which include furniture to reduce the chance of water ingress damage. The extractor fan should be used every time that the shower/bath is used and should be left switched on for a sufficient time afterward to allow for adequate ventilation. Ensure that the fan has been correctly sized for the room in use. The units, under no circumstance, should be fitted in a location where they are regularly subjected to contact with water.

Cleaning

To maintain the surface of your product, wipe with a clean damp cloth and wipe dry, do not use any abrasive cleaning agents or materials. If any harsh chemicals come into contact with the surface of the product, rinse and wipe clean immediately.

For more information

- visit betterbathrooms.com
- email customerservices@buyitdirect.co.uk
- call 03303903062
- write to Trident Business Park, Neptune Way, Huddersfield, HD2 1UA

better 
bathrooms

Part of the BuyItDirect Group